

NOUVEAU

INNOVATION



NOUVEAU

BLUEBAC THERM INSIDE

Lanterneau remplissage verre sur embase polyester isolée

bluetek 
De nature à créer le bien-être

NOUVEAU : BLUEBAC THERM INSIDE

Lanterneau remplissage verre sur embase polyester

Bluebac Therm Inside est le premier appareil pour toitures sèches avec remplissage verre (disponible en double et triple vitrage)



Caractéristiques

- Embase polyester armée fibres de verre parois extérieures protégées par le gel coat hauteur 300 mm isolée 19 mm
- Existe en Fix et Air élec (course 300 mm)
- RAL extérieur possible
- 8 dimensions commerciales disponibles :

Dim com	Dim lum	DROITE		
		DR	B1	B2
80 / 80	80 x 80	•	-	-
110 / 110	100 x 100	-	•	-
120 / 120	100 x 100	-	-	•
150 / 150	140 x 140	-	•	-
150 / 150	130 x 130	-	-	•
80 / 80	80 x 80	•	-	-
80 x 110	70 x 100	-	•	-
120 / 150	100 x 130	-	-	•

■ disponible / - non disponible

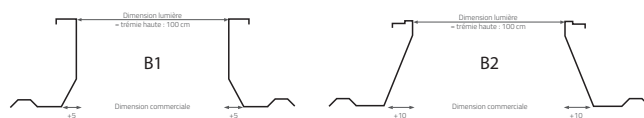

Avantages

- + Esthétique : Vision du ciel
- Confort acoustique
- Réduit la consommation d'énergie dans le bâtiment grâce à l'apport de lumière naturelle
- Confort thermique

Urc = 1,4 W/m².K
Arc = 3,7 m²

(pour un Bluebac Therm Inside
dim com 120 x 150 B2,
Ht 300 mm, triple vitrage)

Du verre
sur toitures sèches !

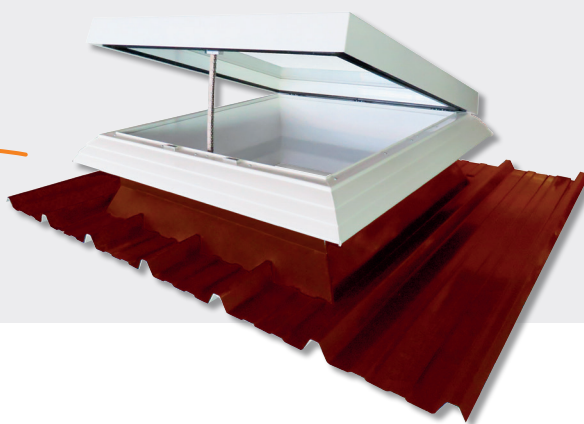

Coupe Bluebac Therm Inside fixe (trémie droite)

Remplissage verre
(double ou triple vitrage)

Embase isolée 19 mm

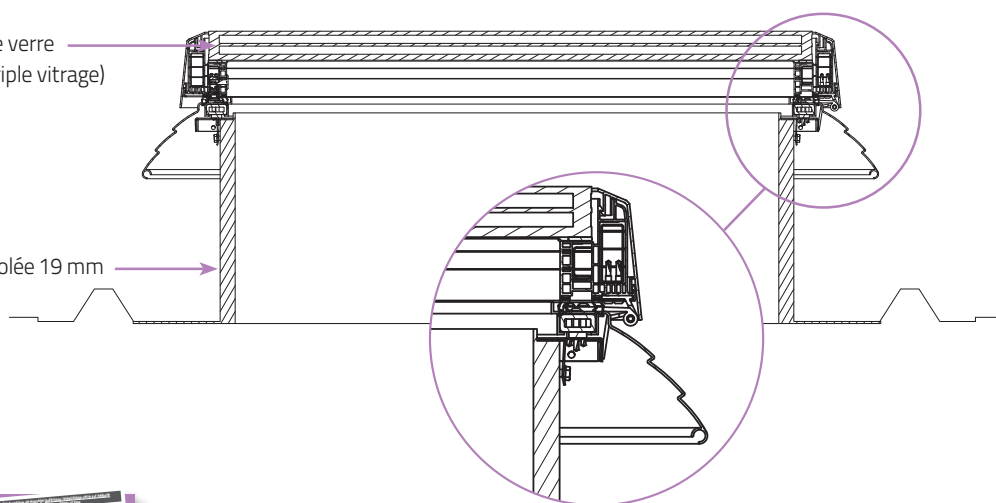

Notice fournie

Produits disponibles



ÉCLAIREMENT
ZENITHAL

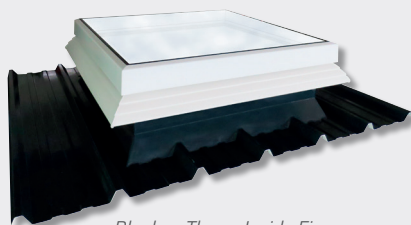

Bluebac Therm Inside Fix



AÉRATION

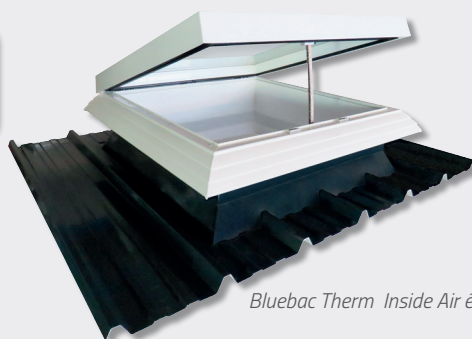

Bluebac Therm Inside Air élec

EXISTE AUSSI : *Gamme Bluebac Therm*

BLUEBAC THERM



ÉCLAIREMENT
ZENITHAL



AÉRATION



ACCÈS TOITURE



DÉSENFUMAGE



BSL
BRISE SOLEIL LUMINEUX®

Urc de 1,4 W/m².K à 2,2 W/m².K



PEARL
INSIDE®

Urc de 1,7 W/m².K à 2,8 W/m².K

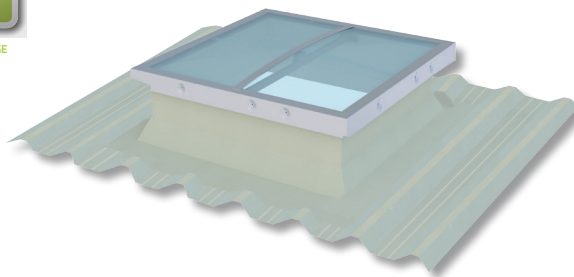

EXISTE AUSSI : *Gamme Inside*

KARAT INSIDE



ÉCLAIREMENT
ZENITHAL



AÉRATION

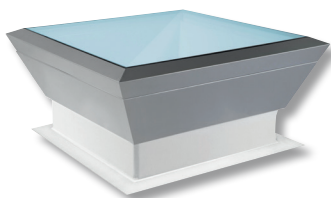

Urc : 0,7 W/m².K
Rw = 30 (-1;-3) dB

PHONI INSIDE



ÉCLAIREMENT
ZENITHAL



AÉRATION



ACCÈS TOITURE



DÉSENFUMAGE

Urc : 1,1 W/m².K
Rw = 37 (0;-1) dB

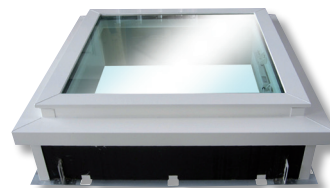

SLICK INSIDE ROND OU CARRÉ



ÉCLAIREMENT
ZENITHAL



AÉRATION



Urc : 1,1 W/m².K
Rw = 29 (-1;-3) dB

STEEL INSIDE



ÉCLAIREMENT
ZENITHAL



AÉRATION



ACCÈS TOITURE



DÉSENFUMAGE

Urc : 1,2 W/m².K
Rw = 34 (-1;-2) dB

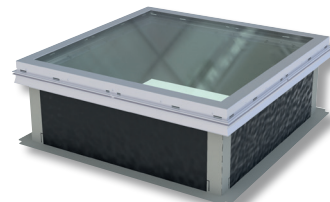

© octobre 2017 / Bluetek se réserve, en fonction des connaissances et des besoins, le droit de modifier sans préavis la composition et les conditions d'utilisation de ses matériaux.
Texte, photos, illustrations non contractuels.

RETROUVEZ NOTRE
GAMME INSIDE
ET LA GAMME
BLUEBAC THERM

